

TOP VIEW

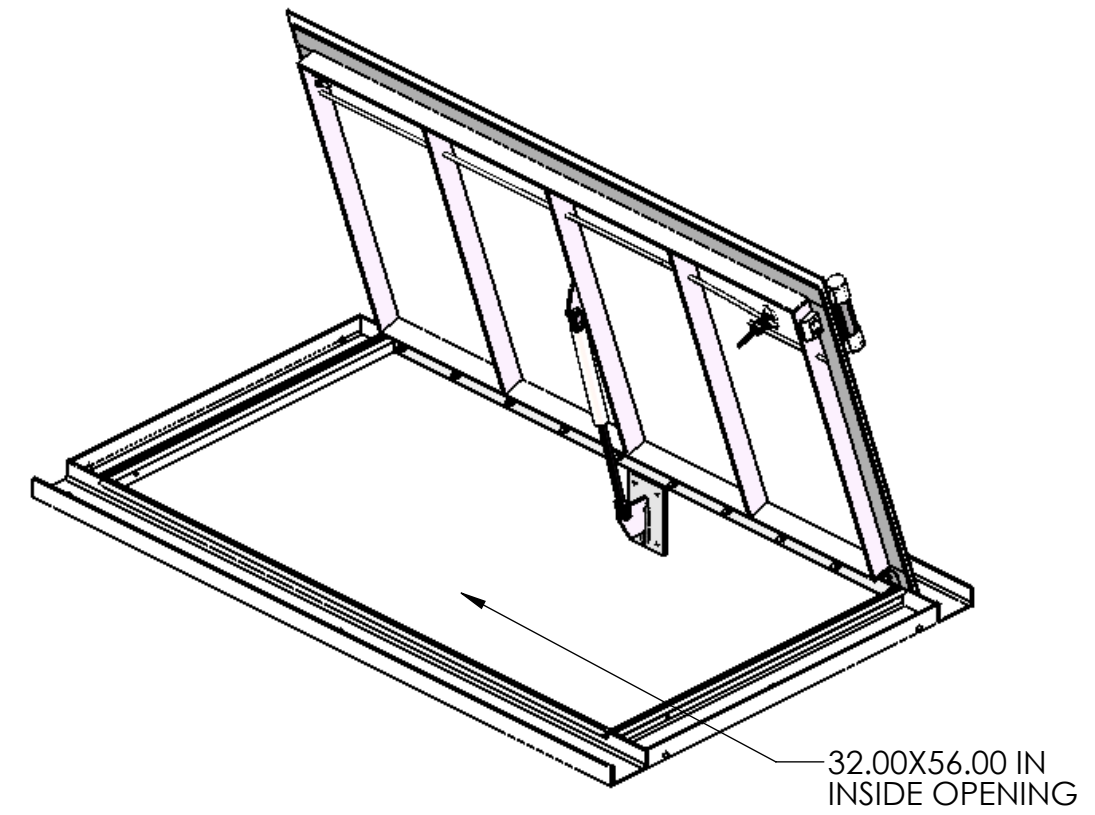

ISOMETRIC VIEW

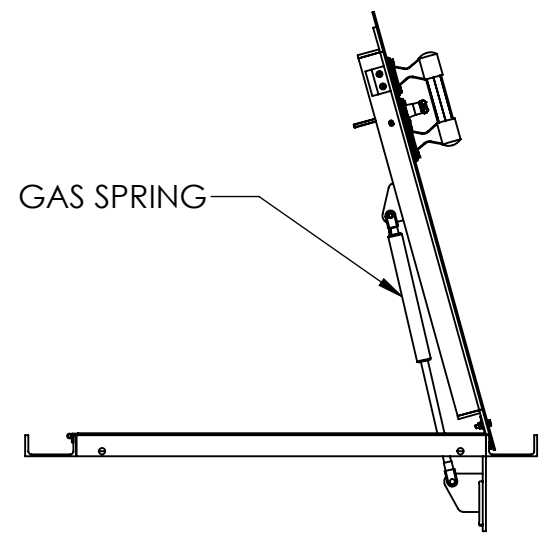

FRONT VIEW

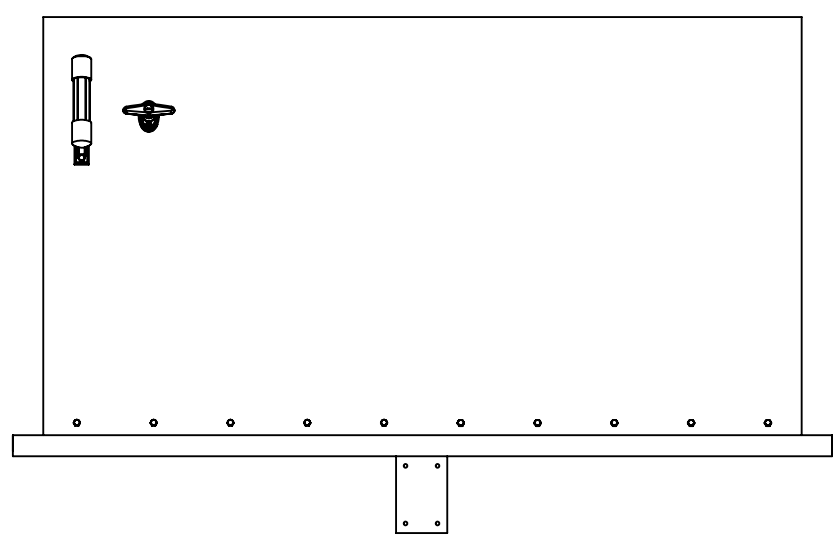

SIDE VIEW



APPROVALS	DATE
DRAWN DLL	11-10-07
CHECKED CDM	11-10-07
APPROVED CDM	11-10-07
SHEET 1 OF 1	
SCALE: 1:15	SIZE: B

USS, INC.
 PHONE: (260) 693-1172 FAX: (260) 693-1178
 WEB SITE: WWW.USSPECIALISTS.COM

USS-HC32X32S

THE INFORMATION ON THIS DRAWING IS PROPRIETARY AND IS NOT TO BE REVEALED TO THIRD PARTIES WITHOUT WRITTEN CONSENT OF A CORPORATE OFFICER OF USS, INC.